

# Data Sheet



Article number: 339707090000

Description: Multibeam 6 Coupling 707.09.0000  
Aluminium relieved & clamp hubs

## Measures

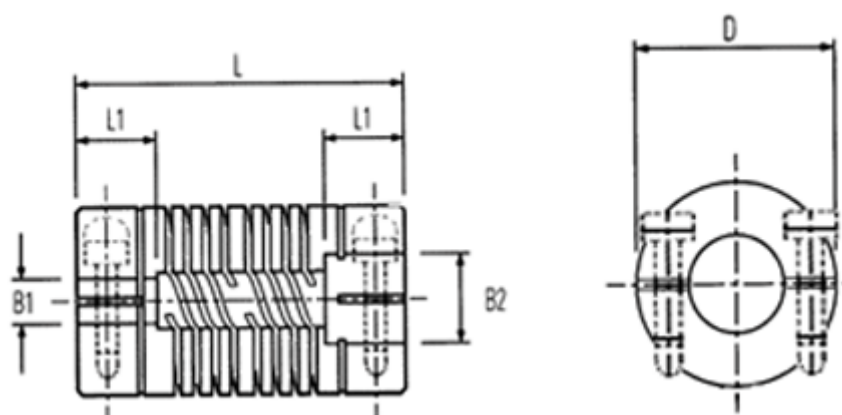

B2: Pre-drilled	= 2.0
B2: Pre-drilled	= 4.00
Cap screw	= M1,6
D	= 9.5
L	= 19.6
L1	= 5.3
Max angular displacement	= 0.12
Max B1 & B2	= 4.76

Max parallel displacement	= 3
Peak Torque NM	= 1.00